

Interior Light <LHD>

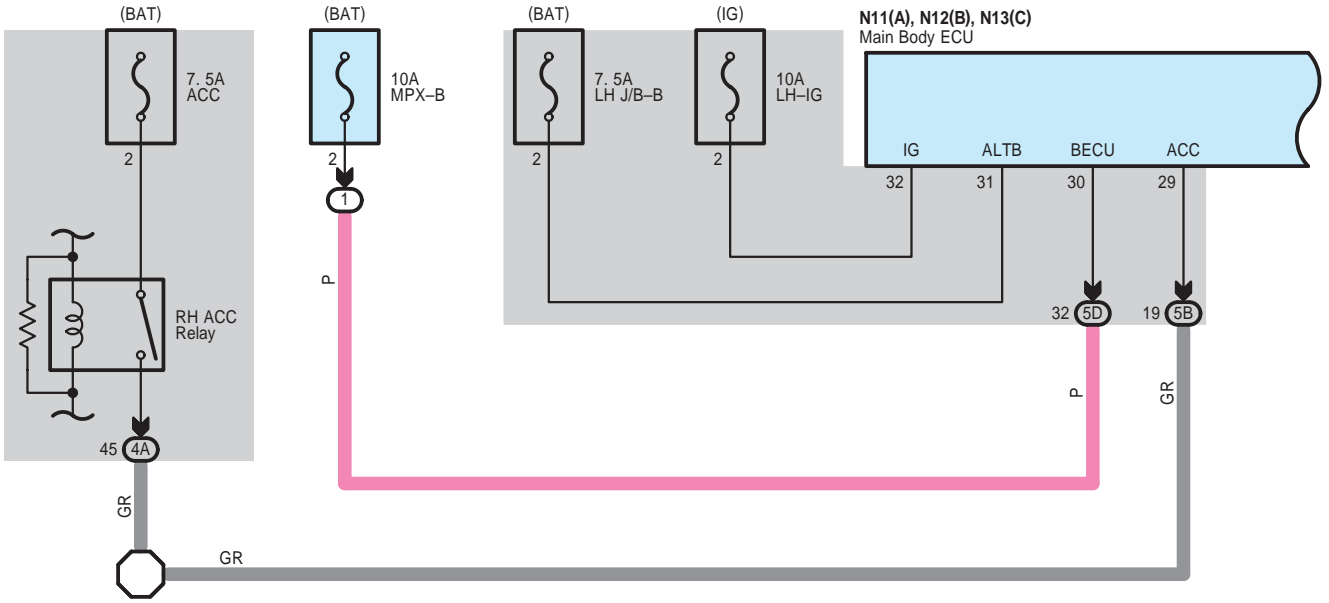

Interior Light <LHD>

N11(A), N12(B), N13(C)
Main Body ECU

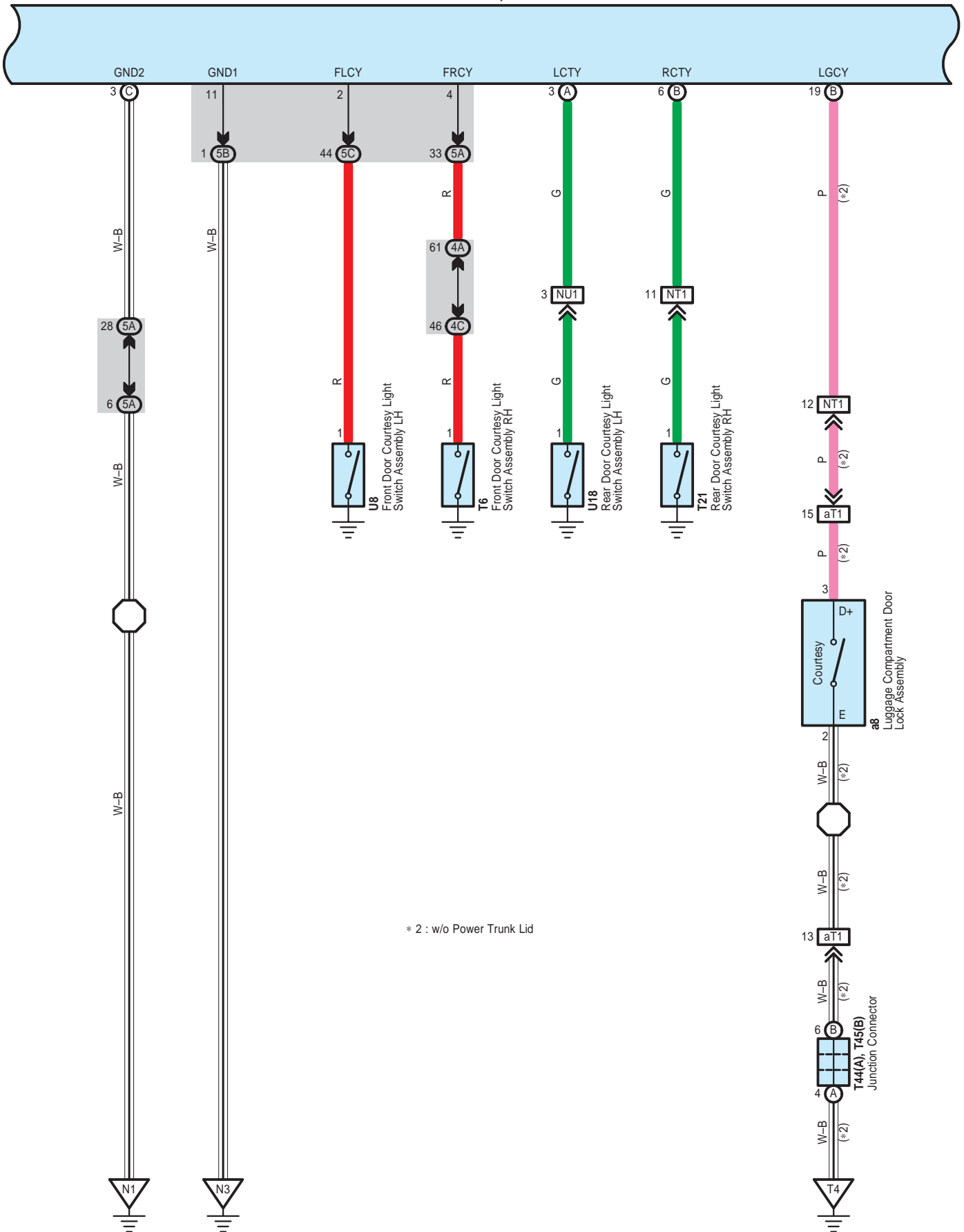

Interior Light <LHD>

N11(A), N12(B), N13(C)
Main Body ECU

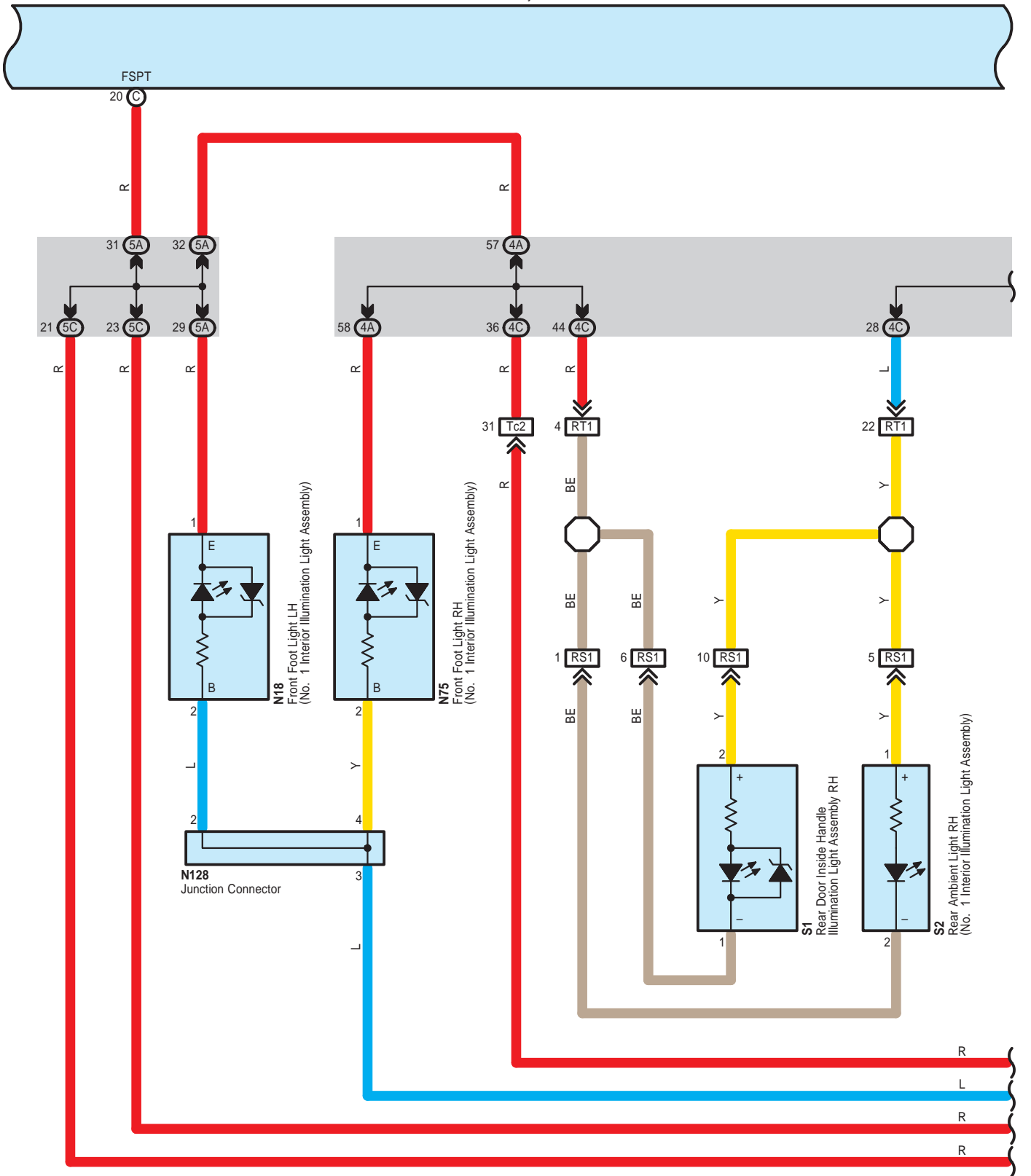

Interior Light <LHD>

N11(A), N12(B), N13(C)
Main Body ECU

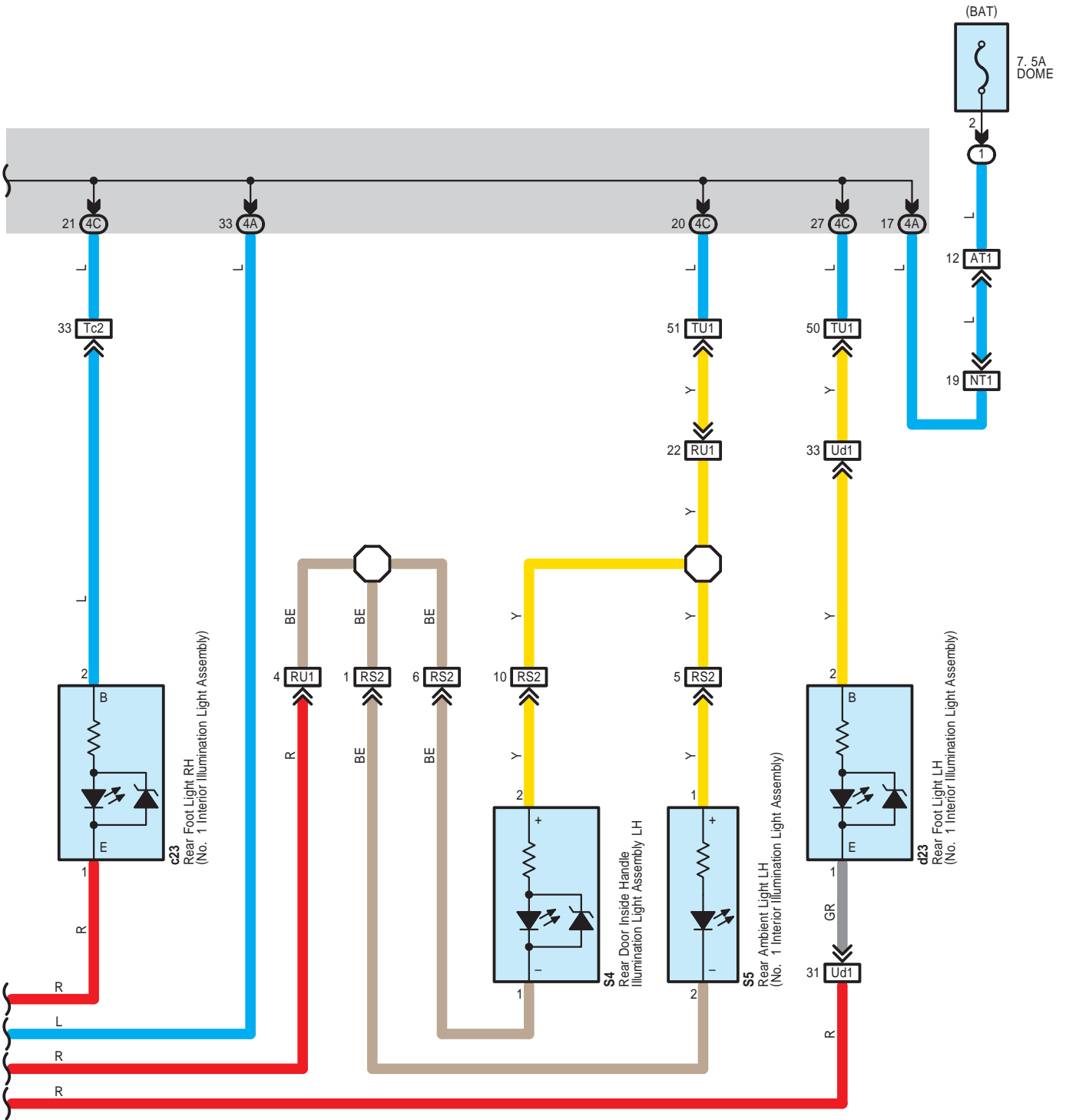

N11(A), N12(B), N13(C)
Main Body ECU

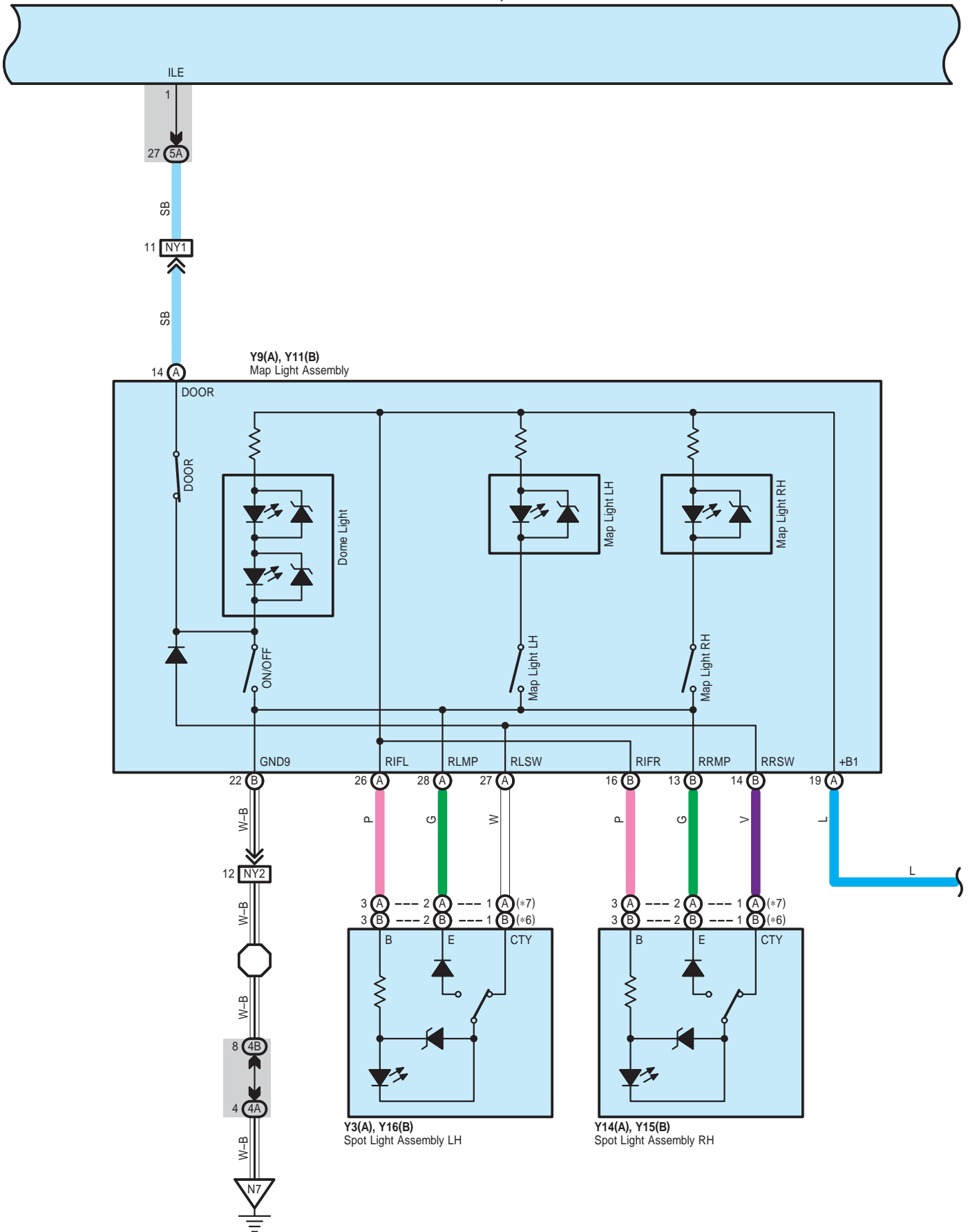

Interior Light <LHD>

N11(A), N12(B), N13(C)
Main Body ECU

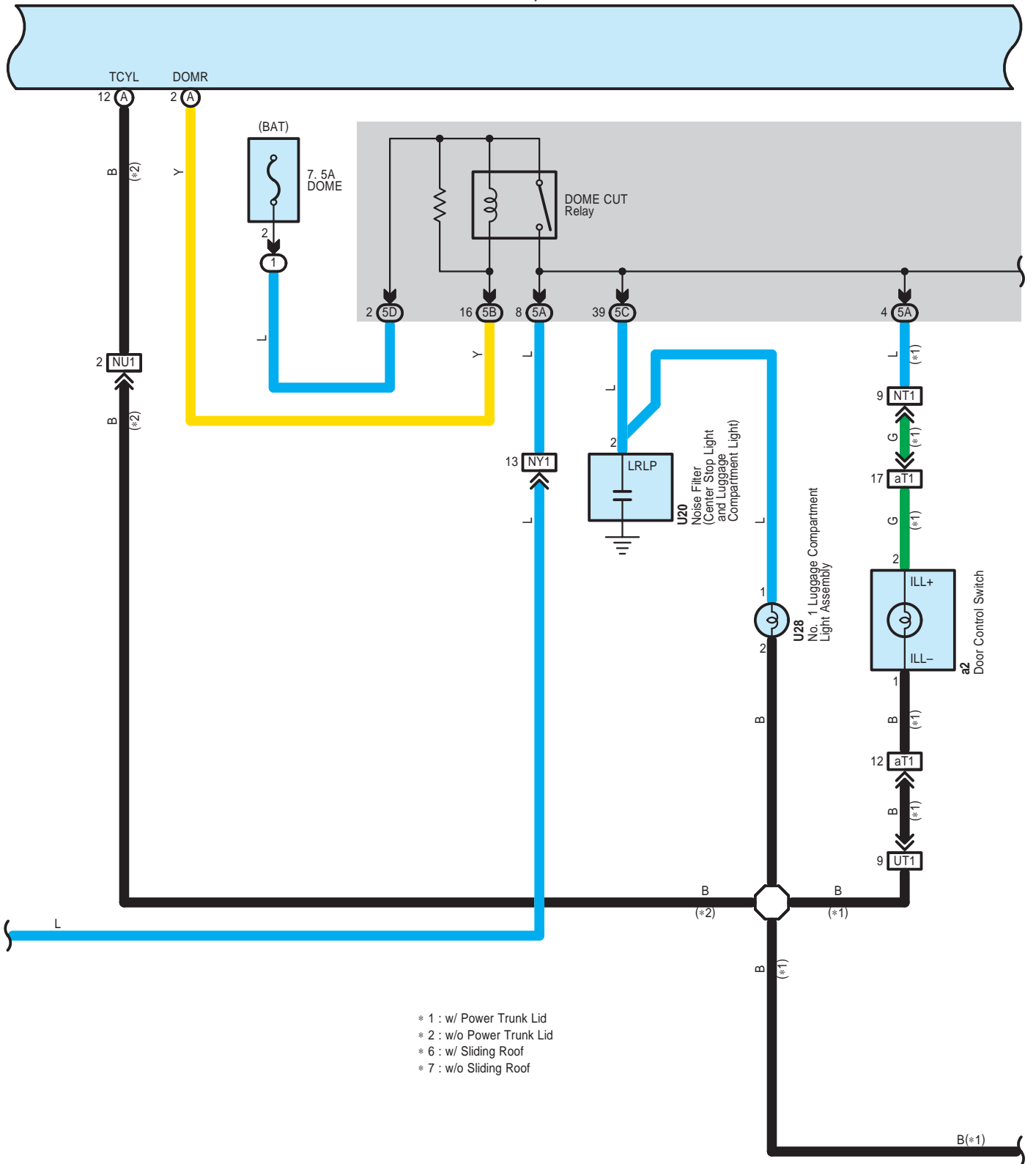

- * 1 : w/ Power Trunk Lid
- * 2 : w/o Power Trunk Lid
- * 6 : w/ Sliding Roof
- * 7 : w/o Sliding Roof

Interior Light <LHD>

N11(A), N12(B), N13(C)
Main Body ECU

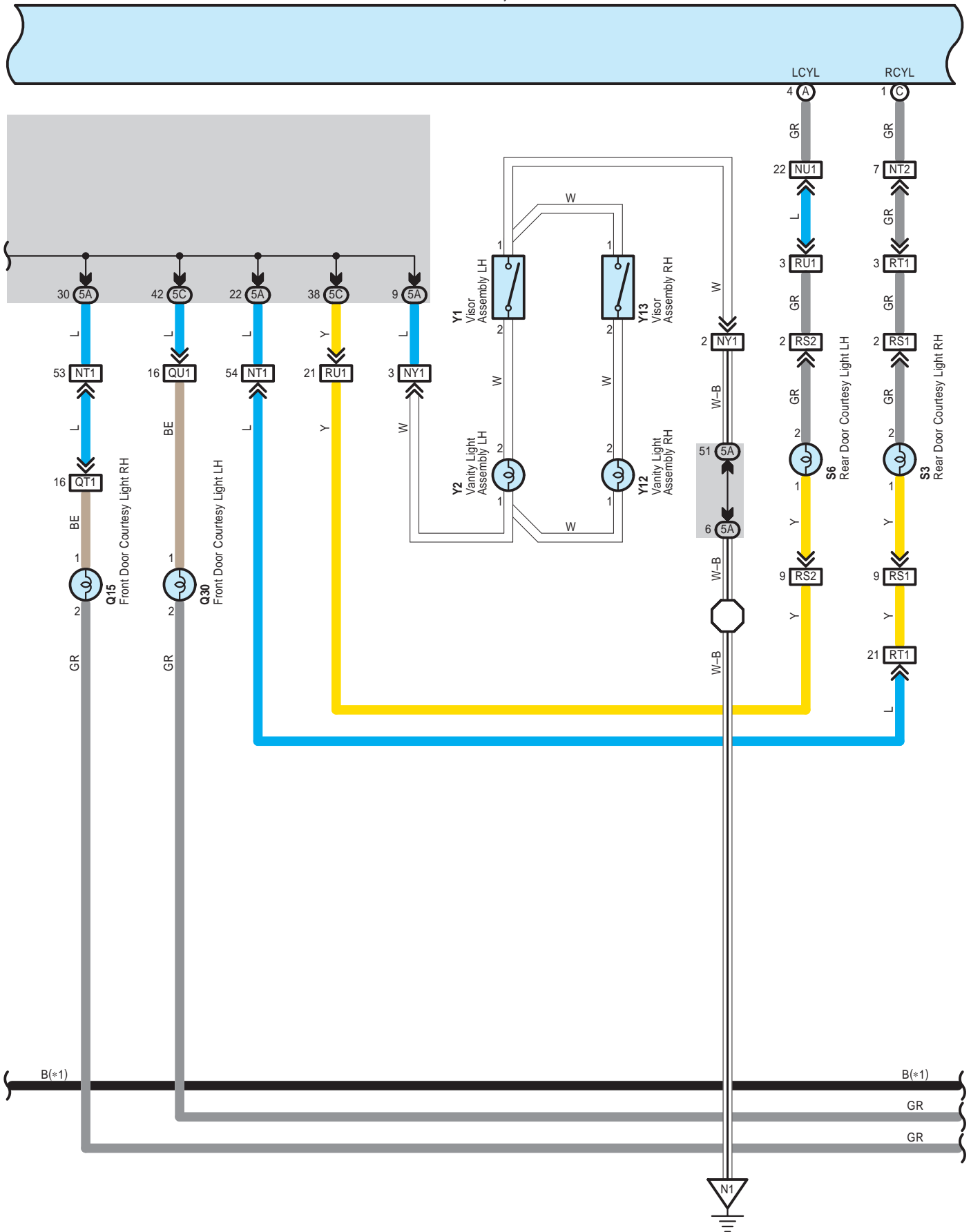

N11(A), N12(B), N13(C)
Main Body ECU

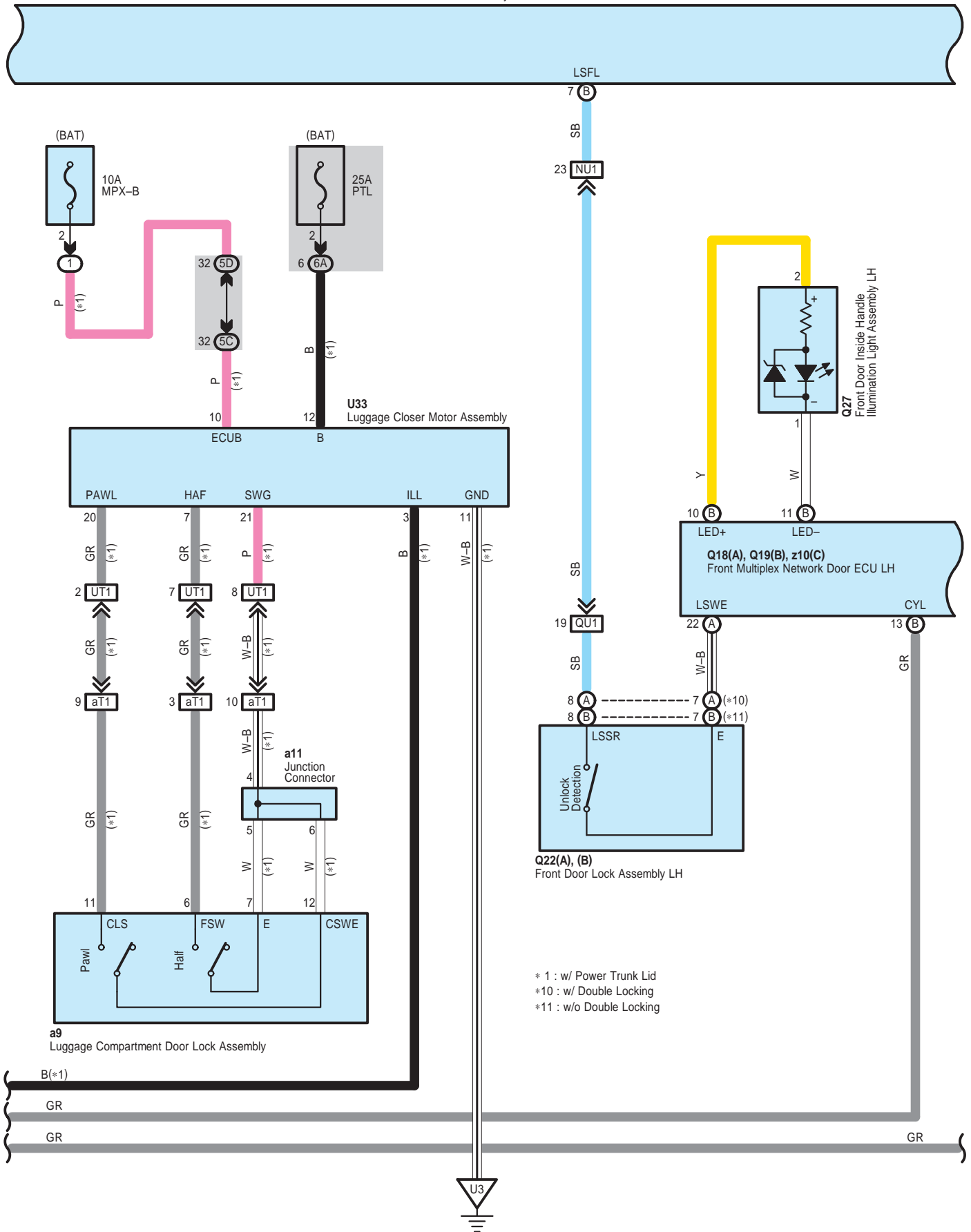

- * 1 : w/ Power Trunk Lid
- * 10 : w/ Double Locking
- * 11 : w/o Double Locking

Interior Light <LHD>

N11(A), N12(B), N13(C)
Main Body ECU

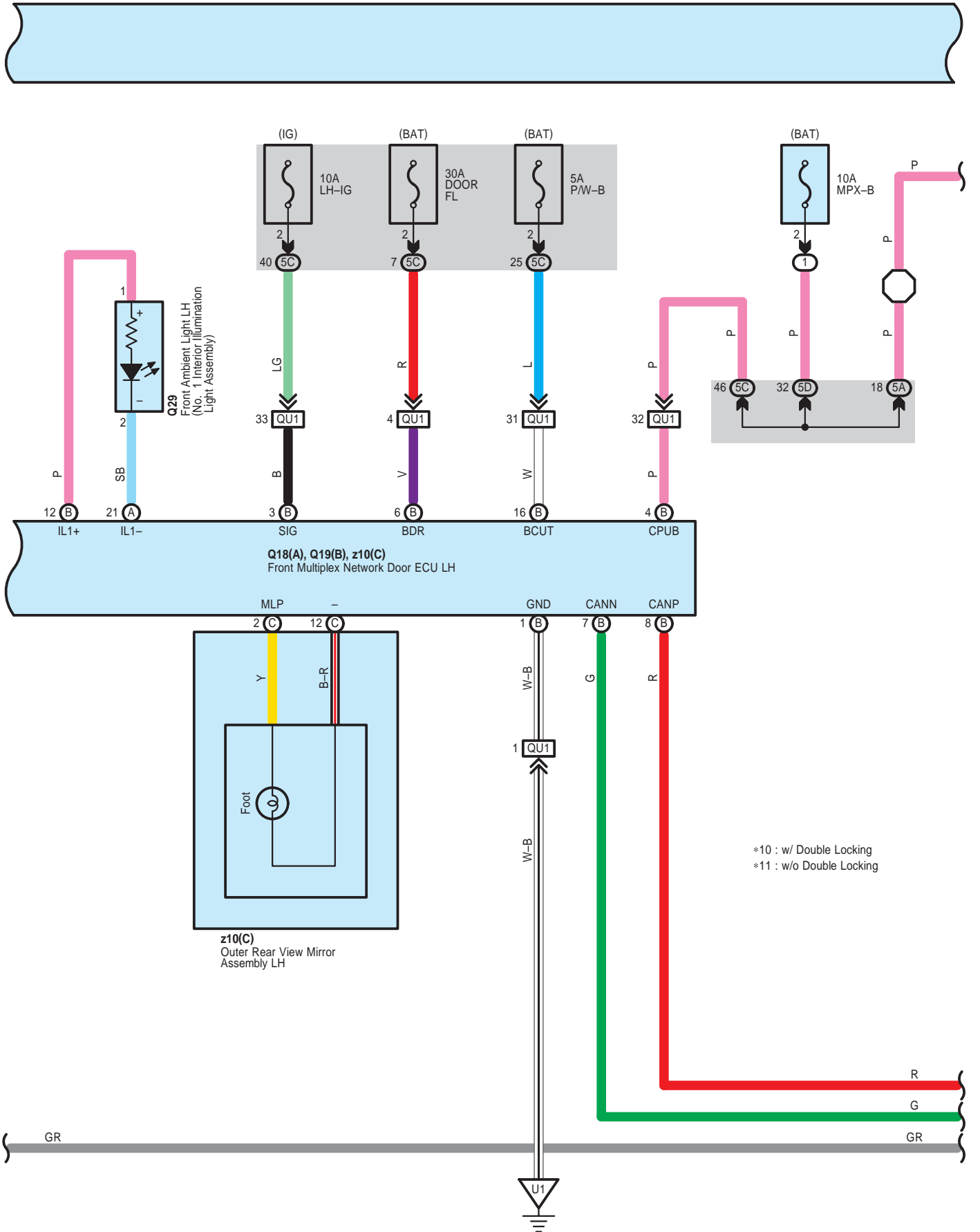

Interior Light <LHD>

N11(A), N12(B), N13(C)
Main Body ECU

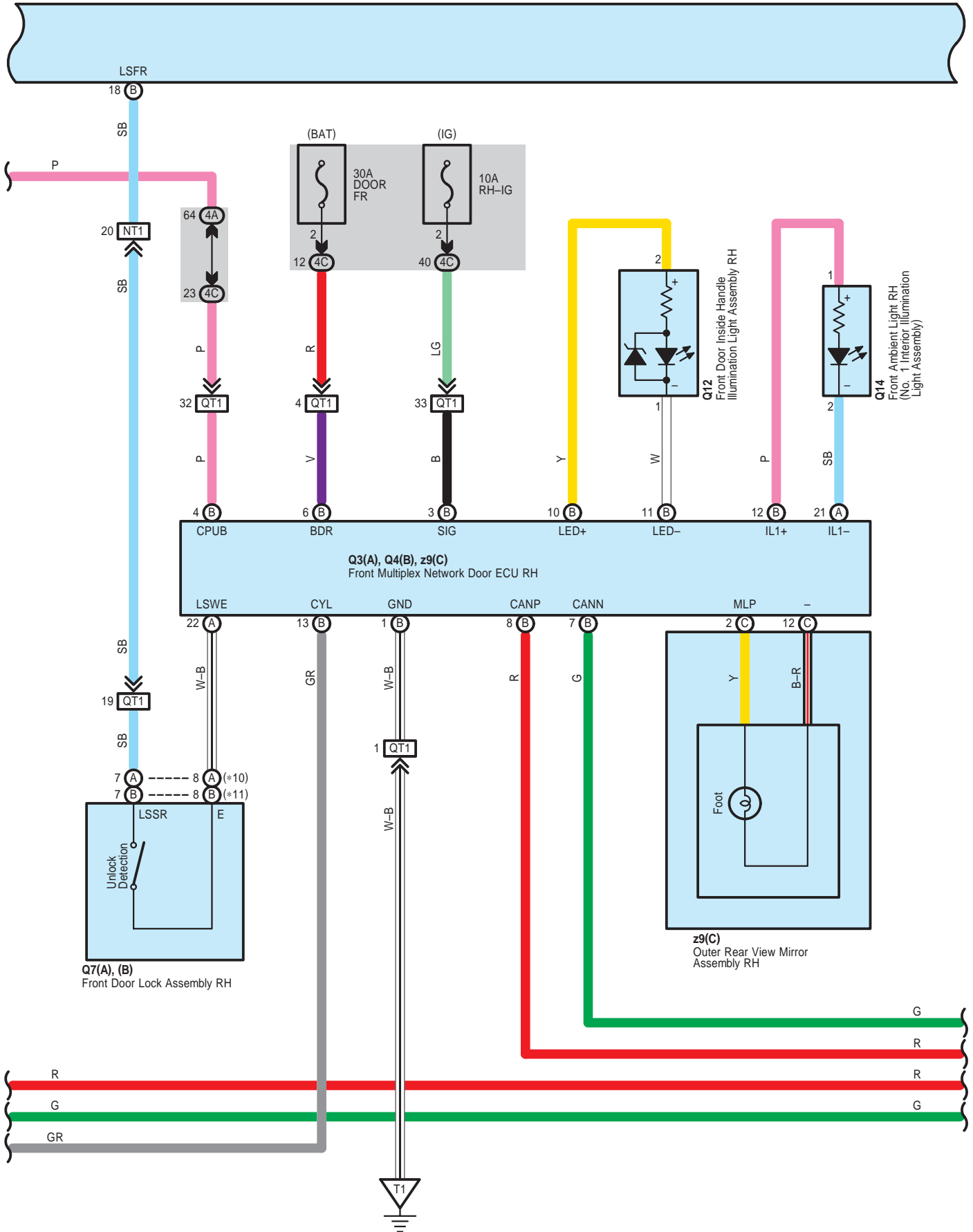

N11(A), N12(B), N13(C)
Main Body ECU

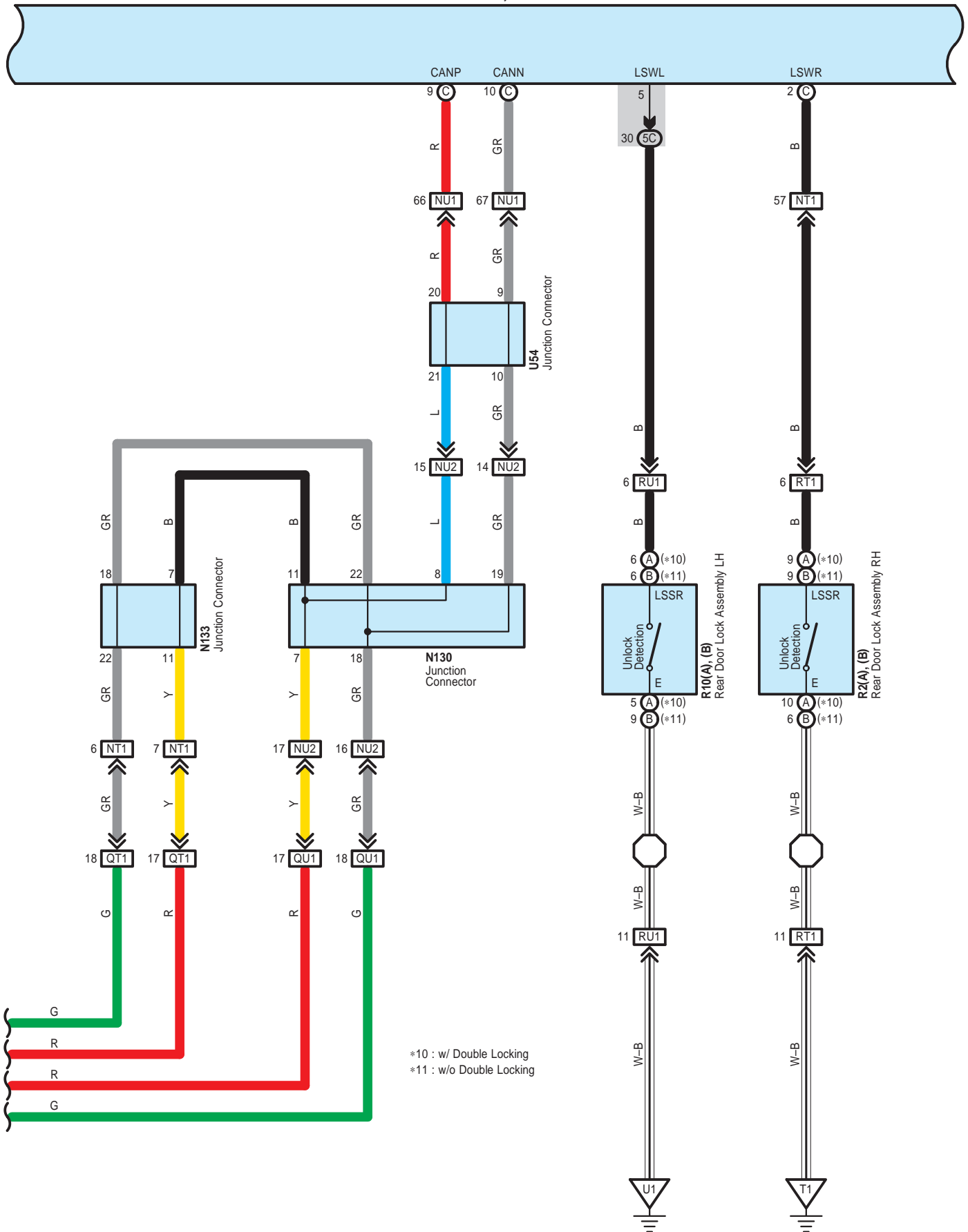

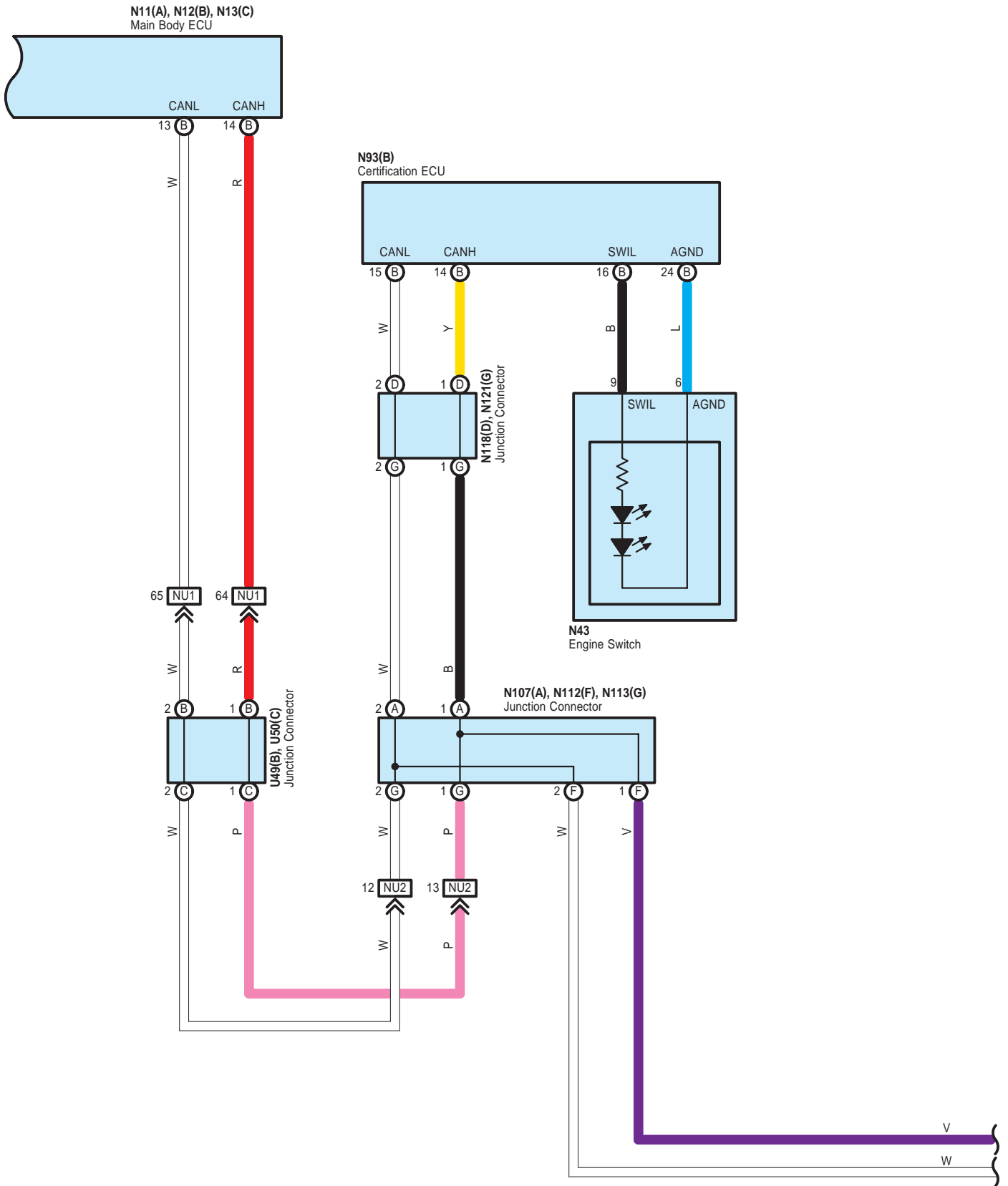

Interior Light <LHD>

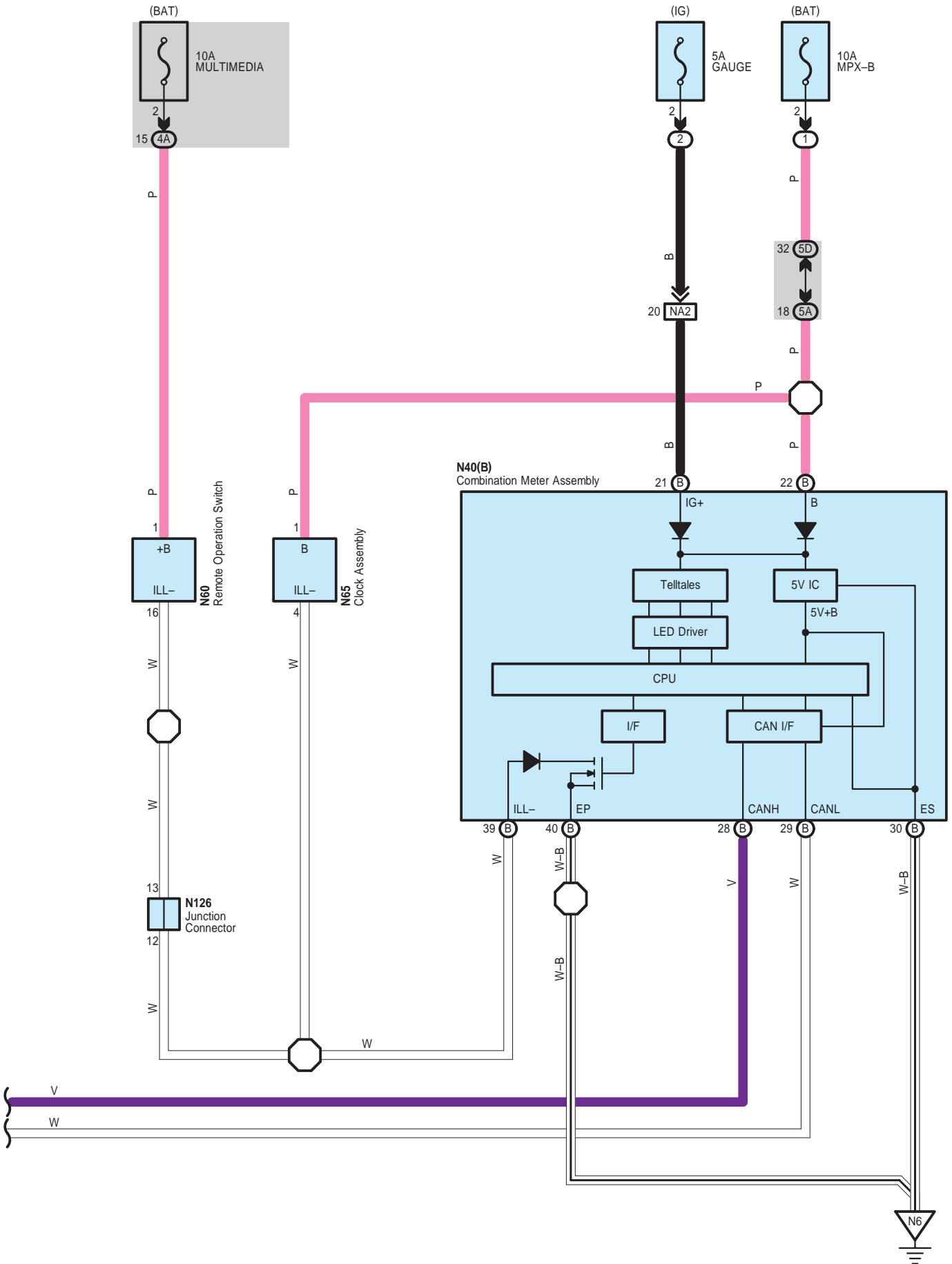

Interior Light <LHD>

N 11
White

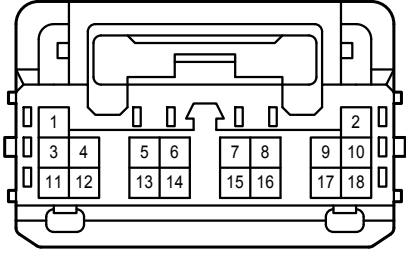

N 12
White

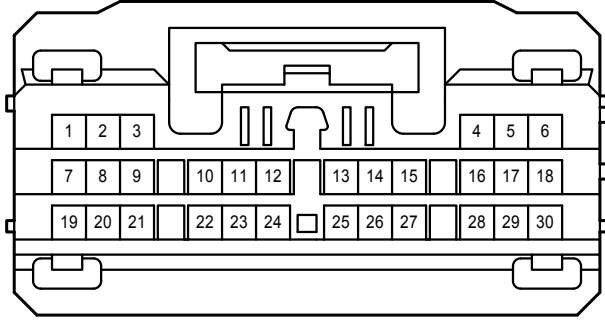

N 13
White

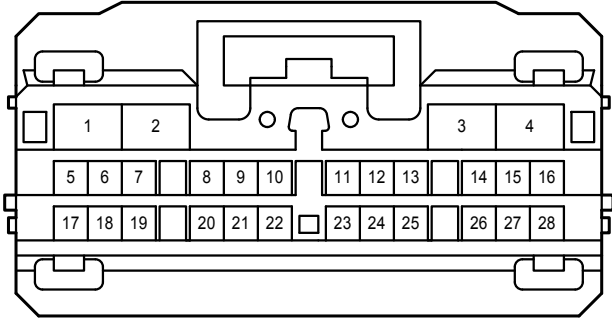

N 18
Gray

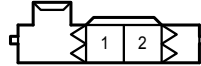

N 40
Black

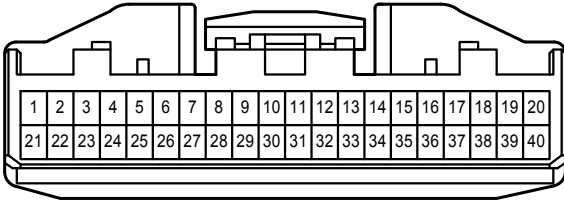

N 43
Black

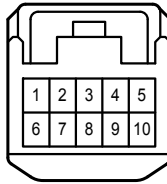

N 60
White

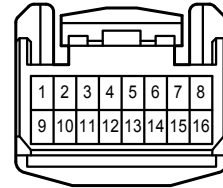

N 65
White

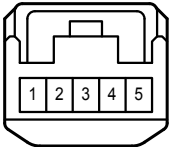

N 75
Gray

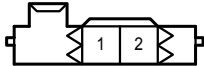

N 93
White

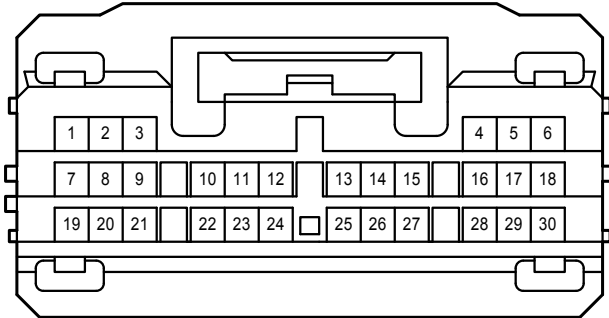

N107
White

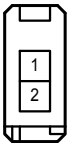

N112
White

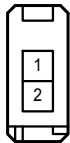

N113
White

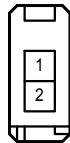

N118
White

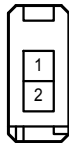

N121
White

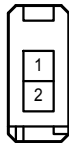

N126
Blue

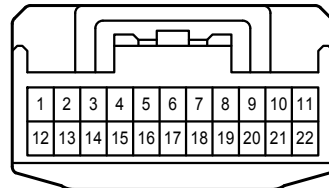

Interior Light <LHD>

N128
Blue

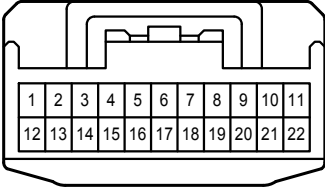

N130
Black

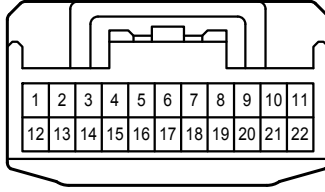

N133
Black

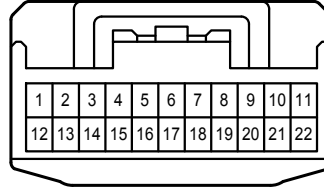

Q 3
White

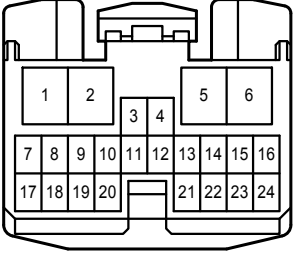

Q 4
White

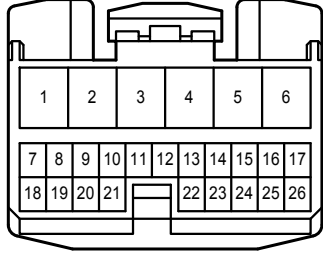

Q 7
White

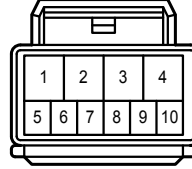

Q 12
White



Q 14
White

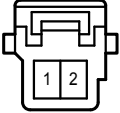

Q 15
White



Q 18
White

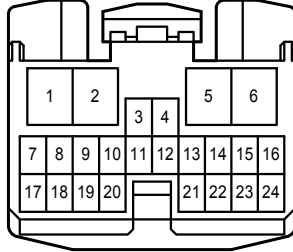

Q 19
White

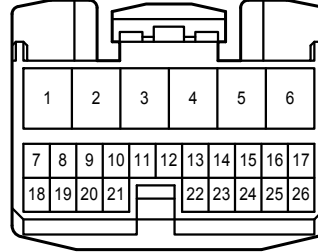

Q 22
White

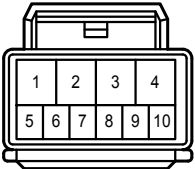

Q 27
White



Q 29
White

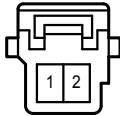

Q 30
White



R 2
White

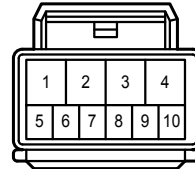

R 10
White

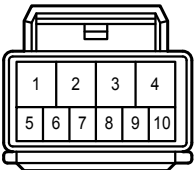

S 1
White



S 2
White



S 3
White



S 4
White



S 5
White



S 6
White



T 6
Black



T 21
Black



T 44
Blue

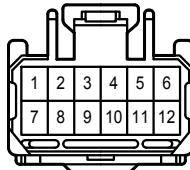

T 45
Blue

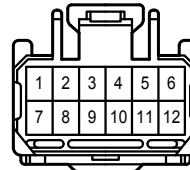

U 8
Black



Interior Light <LHD>

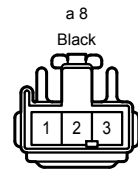
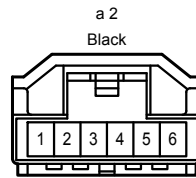
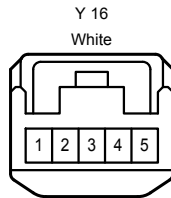
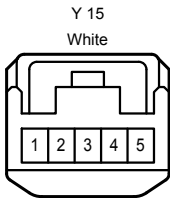
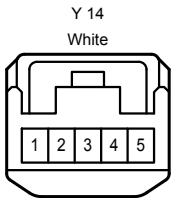
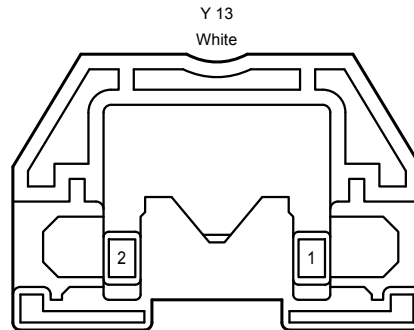
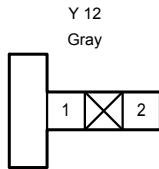
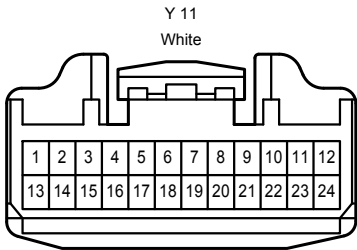
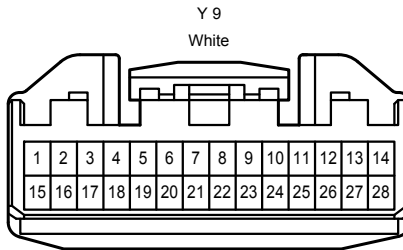
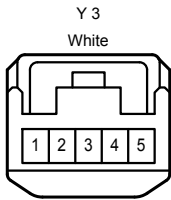
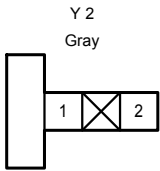
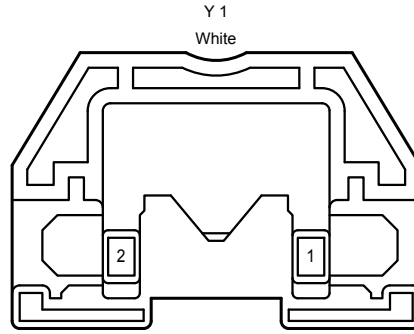
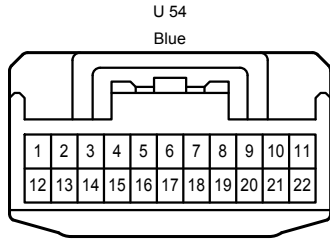
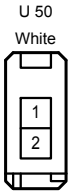
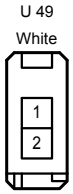
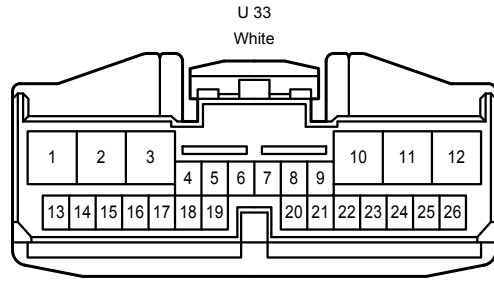
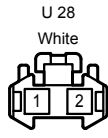
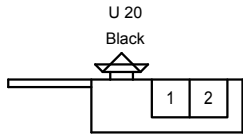

Interior Light <LHD>

a 9
White

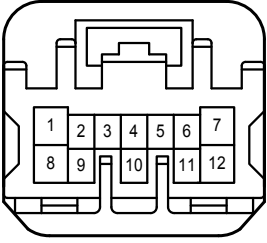

a 11
White

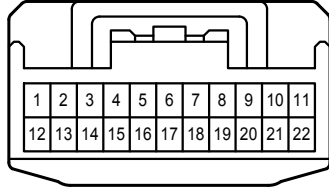

c 23
Black



d 23
Black



z 9
White

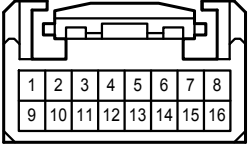

z 10
White

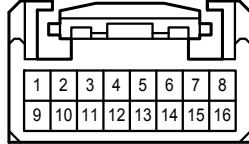

4A
White

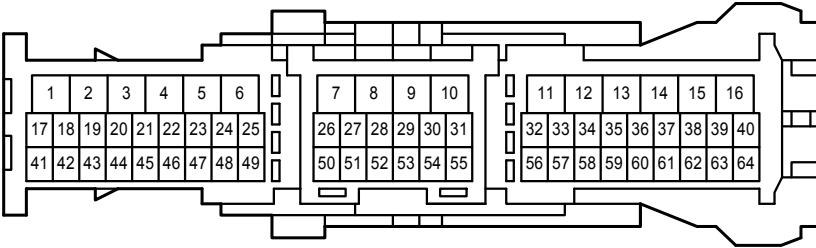

4B
White

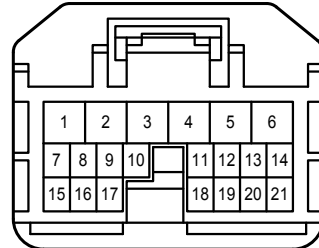

4C
White

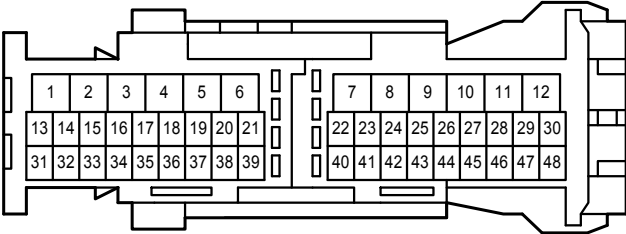

5A
White

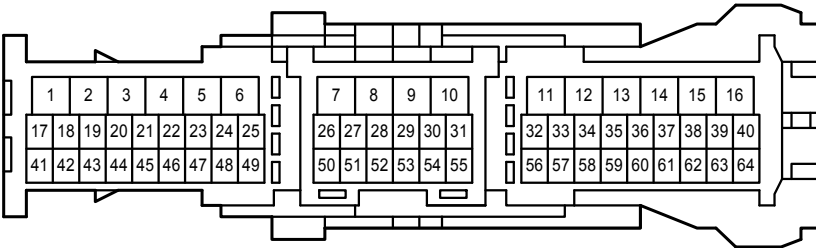

5B
White

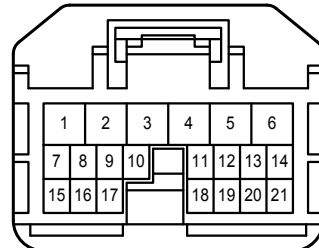

Interior Light <LHD>

5C
White

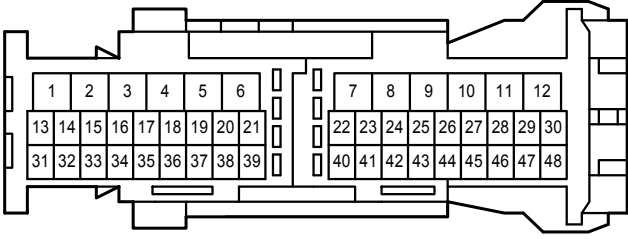

5D
White

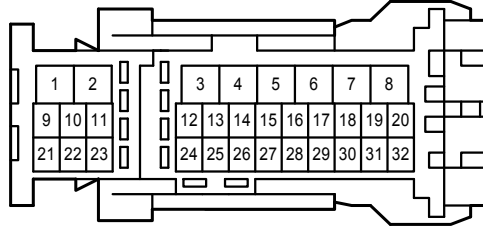

6A
White

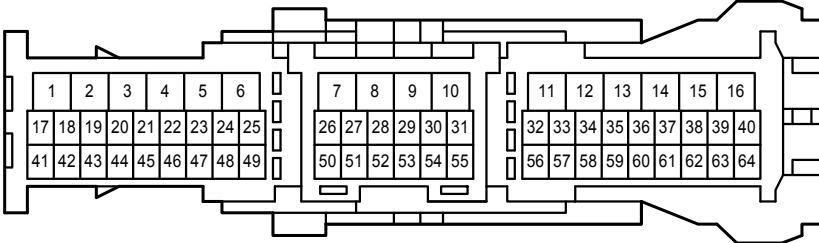

AT1
White

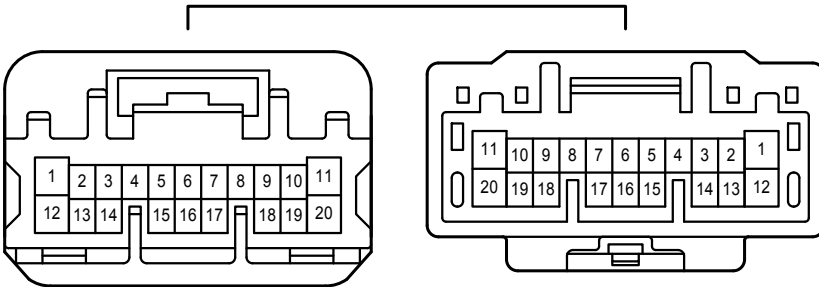

NA2
White

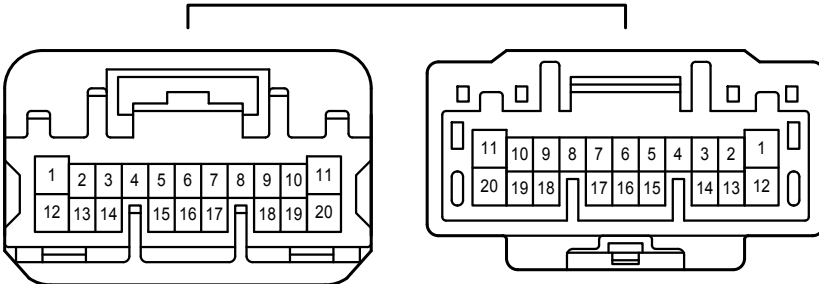

NT1
White

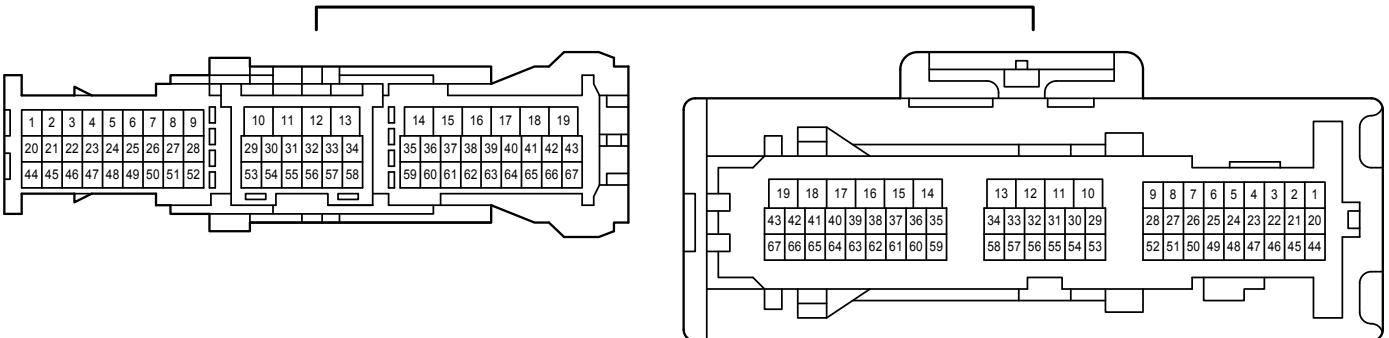

Interior Light <LHD>

NT2
White

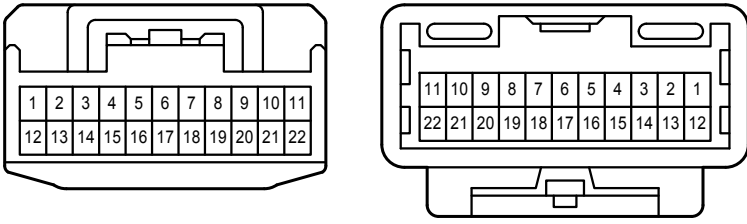

NU1
White

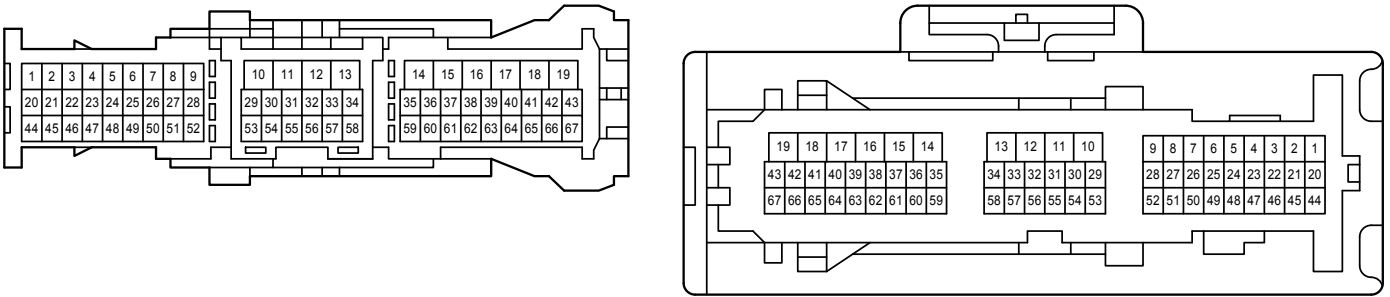

NU2
White

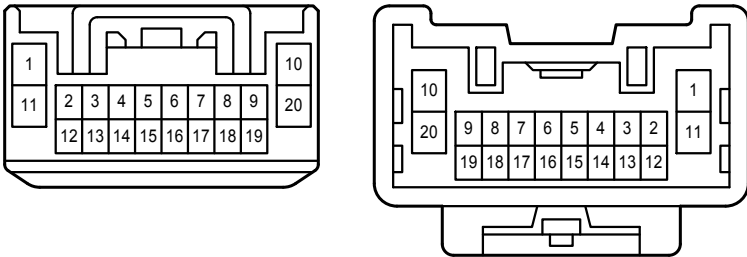

NY1
White

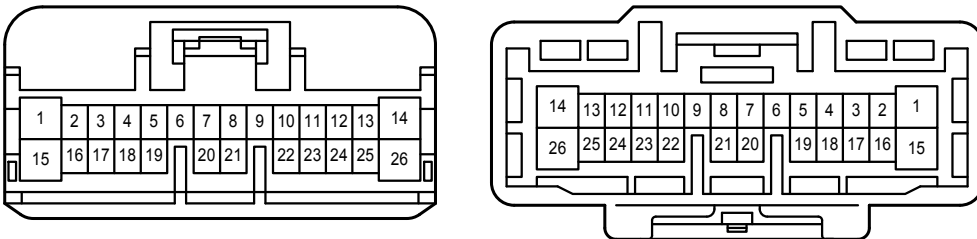

Interior Light <LHD>

NY2
White

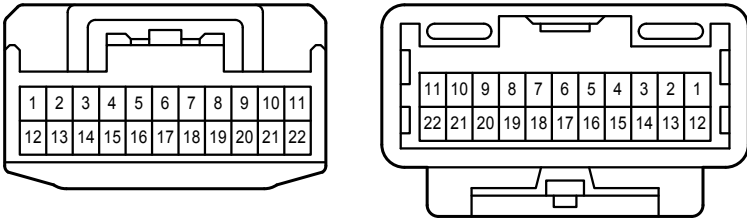

QT1
White

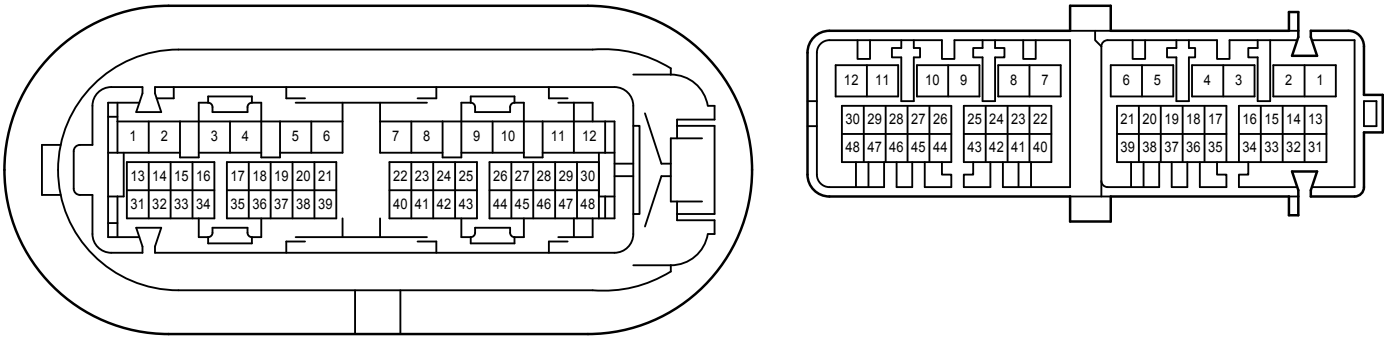

QU1
White

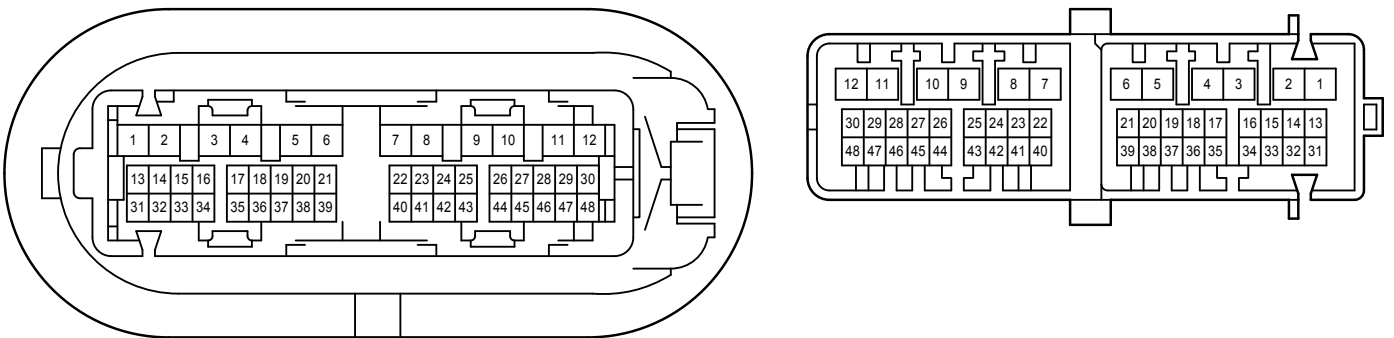

RS1
White

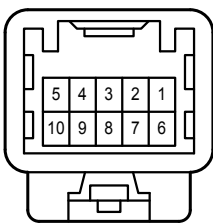
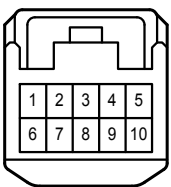

RS2
White

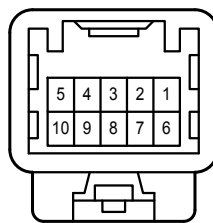
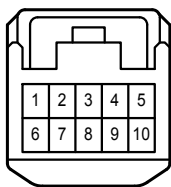

Interior Light <LHD>

RT1
White

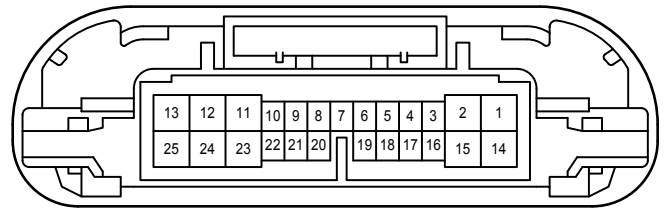
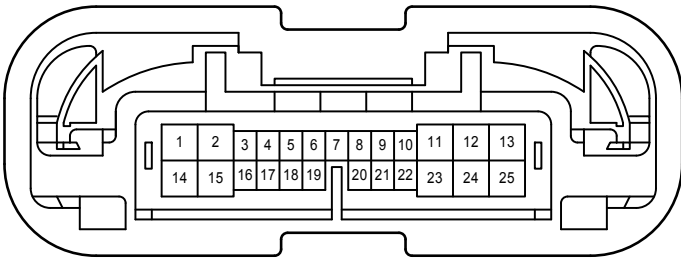

RU1
White

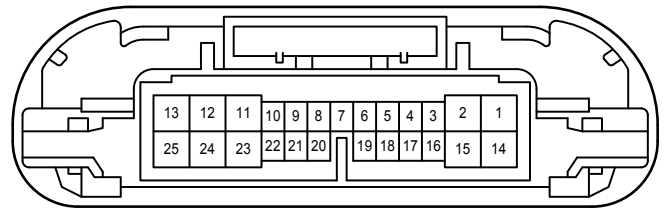
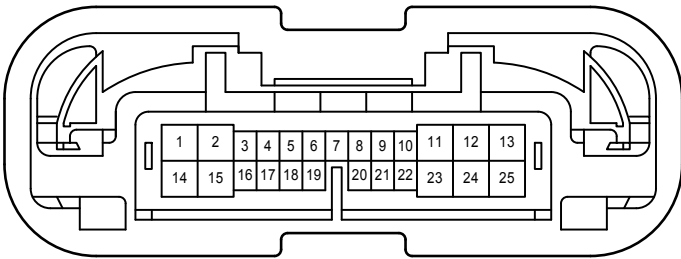

TU1
White

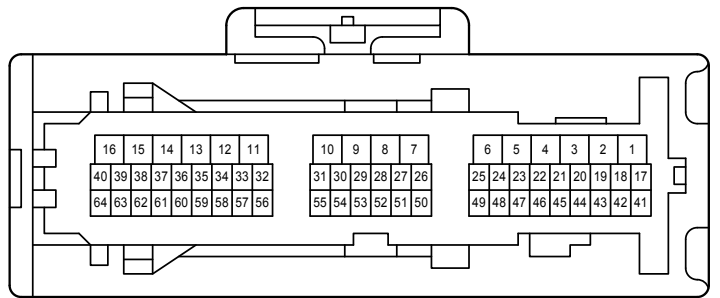
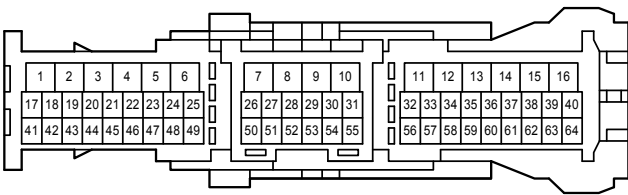

Tc2
White

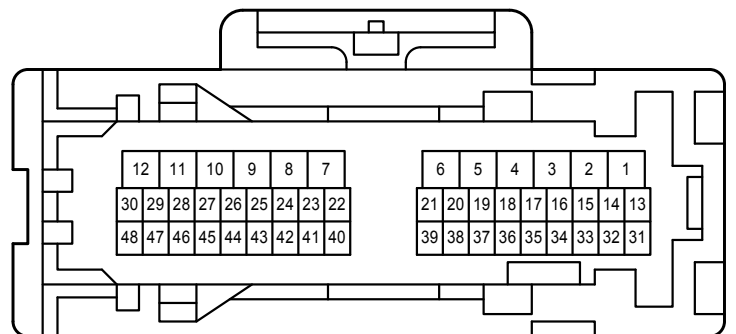
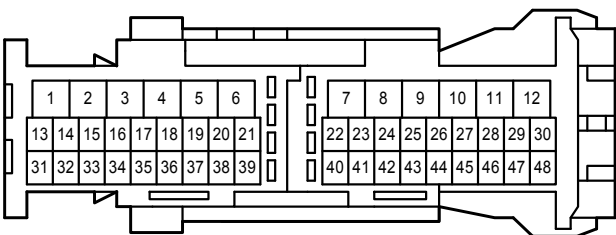

Interior Light <LHD>

UT1
White

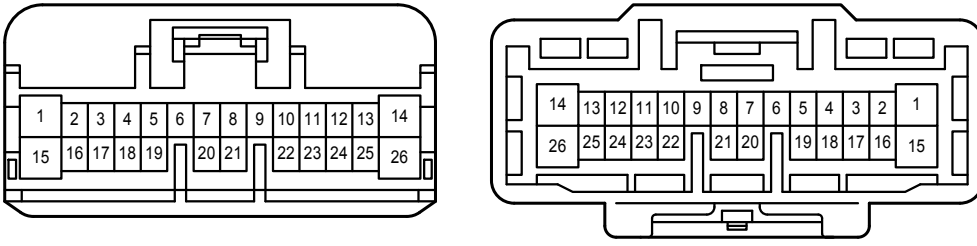

Ud1
White

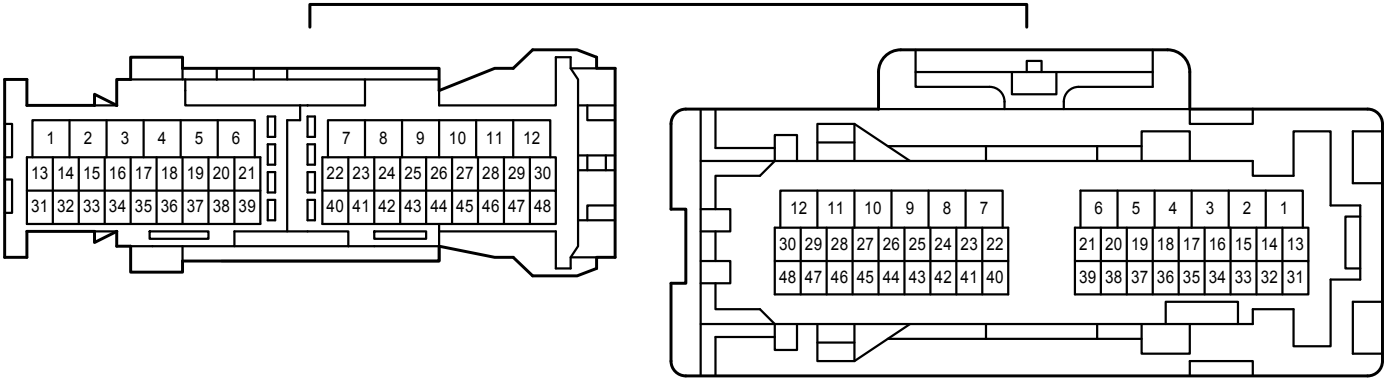

aT1
White

